

Fusto / Drum / Fass				
Cod.	Diametro filo Wire diameter Draht Durchmesser	Diametro fusto Drum diameter Fass Durchmesser	Altezza Height Höhe	Peso netto Net weight Nettogewicht
TA	0,8 ÷ 1,2 mm	520 mm	790 mm	250 Kg
TB	≥ 1,0 mm	580 mm	790 mm	350 Kg
TF	≥ 1,0 mm	660 mm	790 mm	450 Kg

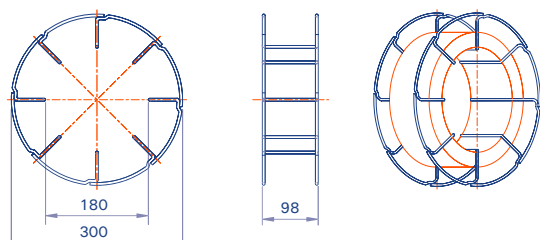

Bobina / Spool / Spule				
Cod.	Diametro interno Inner diameter Innerdurchmesser	Diametro esterno Outer diameter Aussen durchmesser	Larghezza Width Breite	Peso netto Net weight Nettogewicht
RE	180 mm	300 mm	98 mm	15 Kg
RF	180 mm	300 mm	98 mm	16 Kg
RG	180 mm	300 mm	98 mm	18 Kg

EN ISO 544 : B300

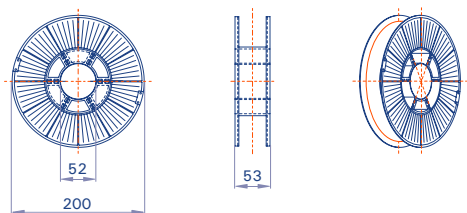

Bobina / Spool / Spule				
Cod.	Diametro foro Hole diameter Loch Durchmesser	Diametro esterno Outer diameter Aussen durchmesser	Larghezza Width Breite	Peso netto Net weight Nettogewicht
RB	52 mm	200 mm	53 mm	5 Kg

EN ISO 864 : D200

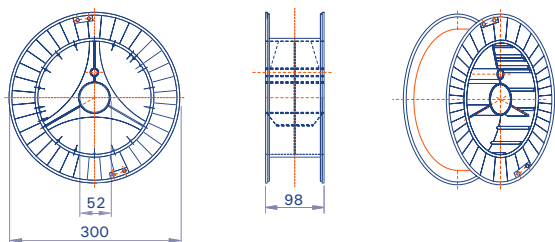

Bobina / Spool / Spule				
Cod.	Diametro foro Hole diameter Loch Durchmesser	Diametro esterno Outer diameter Aussen durchmesser	Larghezza Width Breite	Peso netto Net weight Nettogewicht
RC	52 mm	300 mm	98 mm	15 Kg

EN ISO 864 : D300

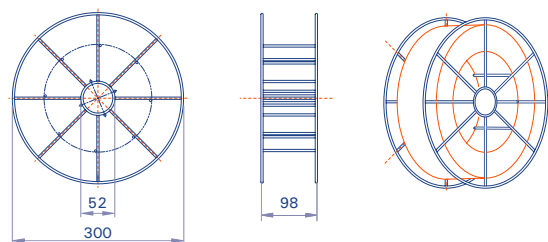

Bobina / Spool / Spule				
Cod.	Diametro foro Hole diameter Loch Durchmesser	Diametro esterno Outer diameter Aussen durchmesser	Larghezza Width Breite	Peso netto Net weight Nettogewicht
RT	52 mm	300 mm	98 mm	15 Kg
RU	52 mm	300 mm	98 mm	16 Kg
RV	52 mm	300 mm	98 mm	18 Kg

EN ISO 544 : BS300

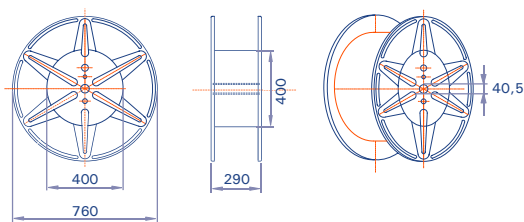
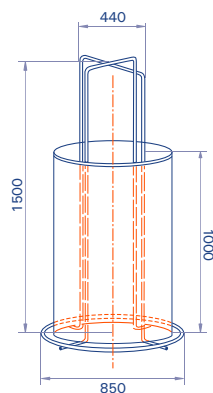
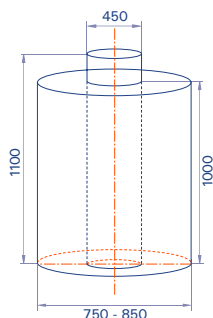
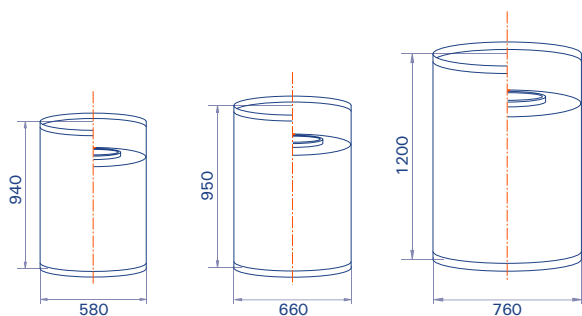
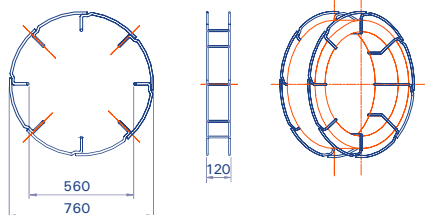
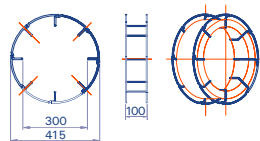

### Bobina / Spool / Spule

Cod.	Diametro interno Inner diameter Innerdurchmesser	Diametro esterno Outer diameter Aussen durchmesser	Larghezza Width Breite	Peso netto Net weight Nettogewicht
LB	300 mm	415 mm	100 mm	25 Kg
LC	300 mm	415 mm	100 mm	27 Kg
LN	560 mm	760 mm	120 mm	90 Kg
LM	560 mm	760 mm	120 mm	100 Kg

### Fusto / Drum / Fass

Cod.	Diametro Diameter Durchmesser	Altezza Height Höhe	Peso netto Net weight Nettogewicht
TS	580 mm	940 mm	380 Kg
TI	660 mm	950 mm	550 Kg
TR	760 mm	1200 mm	1000 Kg

### Matassone / Coil

Cod.	Diametro Diameter Durchmesser	Altezza Height Höhe	Peso netto Net weight Nettogewicht
HN	850 mm	1000 mm	1000 Kg

### Bicocca / Stem frame / Kronenstock

Cod.	Diametro Diameter Durchmesser	Altezza Height Höhe	Peso netto Net weight Nettogewicht
GF	750 ÷ 850 mm	1500 mm	1000 Kg

### Bobina metallica / Metal bobbin / Grosspule

Cod.	Diametro interno Inner diameter Innerdurchmesser	Diametro esterno Outer diameter Aussen durchmesser	Larghezza Width Breite	Peso netto Net weight Nettogewicht
NH	400 mm	760 mm	290 mm	300 ÷ 400 Kg